

Nomme le dessin et entoure-le si tu dis « ou » : outils, oursin, poule, lézard, kangourou, igloo, mouton, scoubidou, mouche, roue

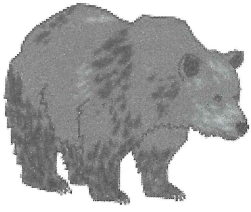

OU
ou

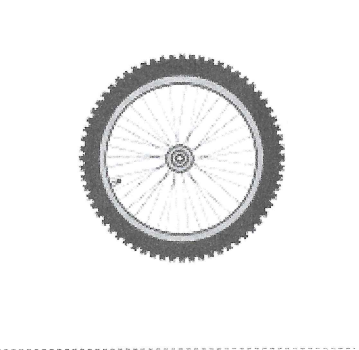
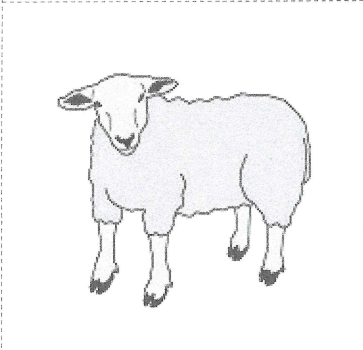
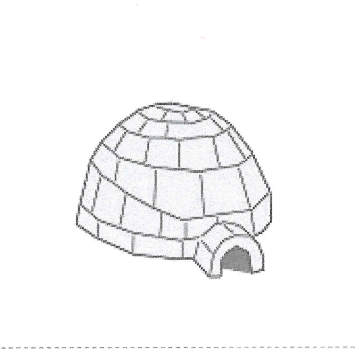
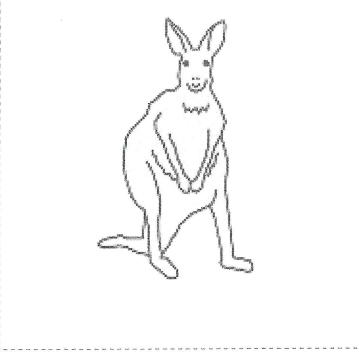
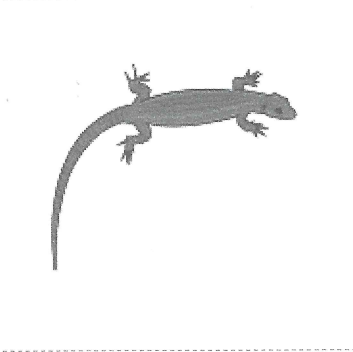
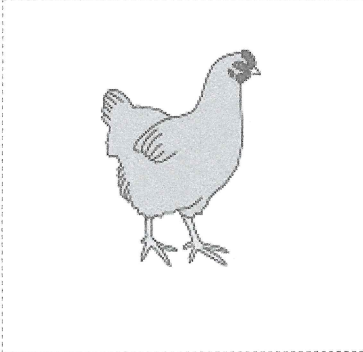
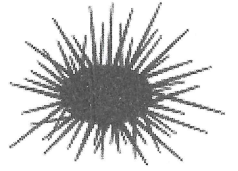
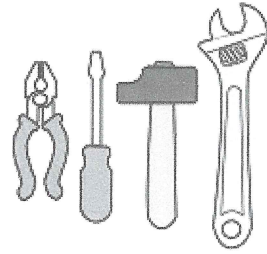

 (X), feutre (F)

(F) O U O U O U

(F) ou ou ou ou

(F) ou ou ou ou ou ou

(X) ou ou ou ou ou ou ou ou ou ou

(X) ou ou ou

la date: _____

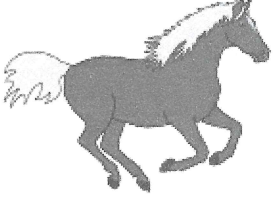

CH ch

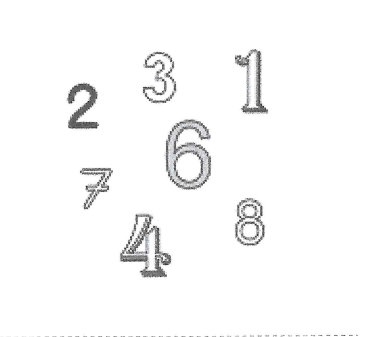
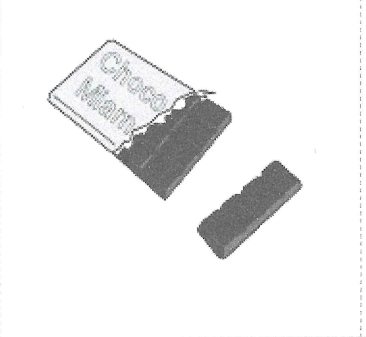
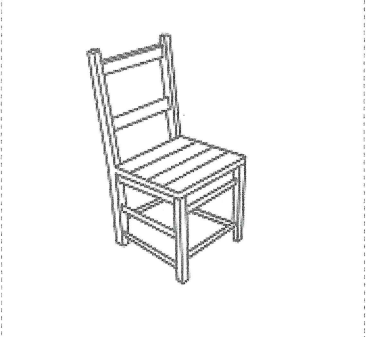
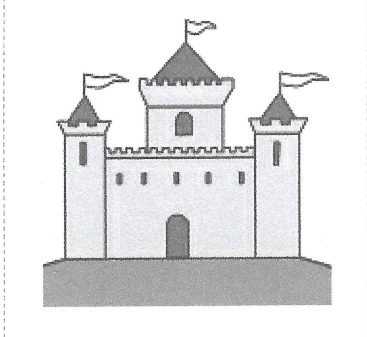
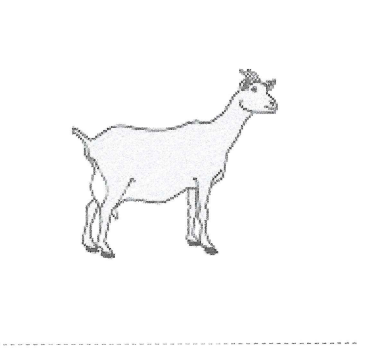
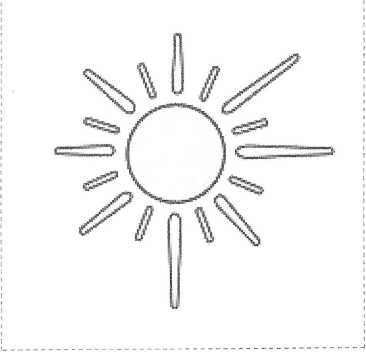
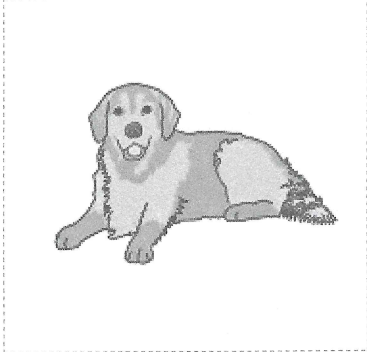
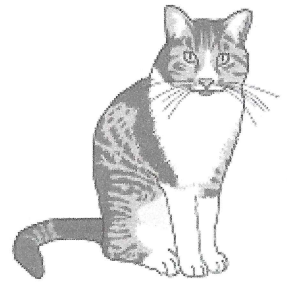
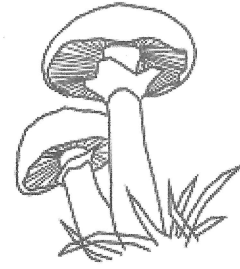

 (X), au feutre (F)

(F) C H C H C H

(F) ch ch ch ch ch

(F) ch ch ch ch ch ch ch

(X) ch ch ch ch ch ch ch ch ch ch ch

(X) ch ch ch

5									
---	--	--	--	--	--	--	--	--	--

Je m'appelle : _____

VERS LA NOTION DE DIZAINE RÉALISER DES GROUPEMENTS DE 10 OBJETS



Dessine
(Colle) 10 pièces dans chaque coffre puis colorie le couvercle
du coffre lorsqu'il est rempli.

- Avec aide
- Sans aide

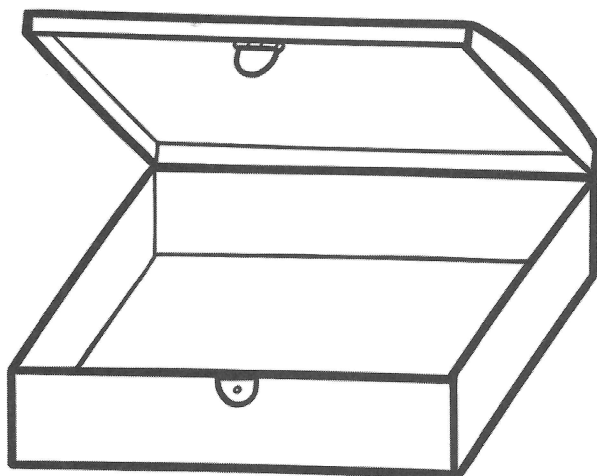
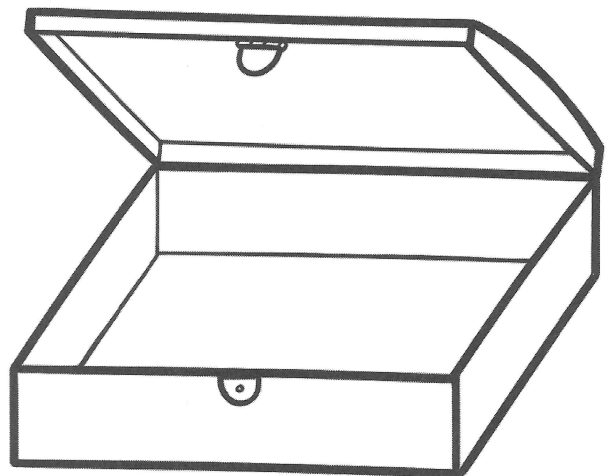
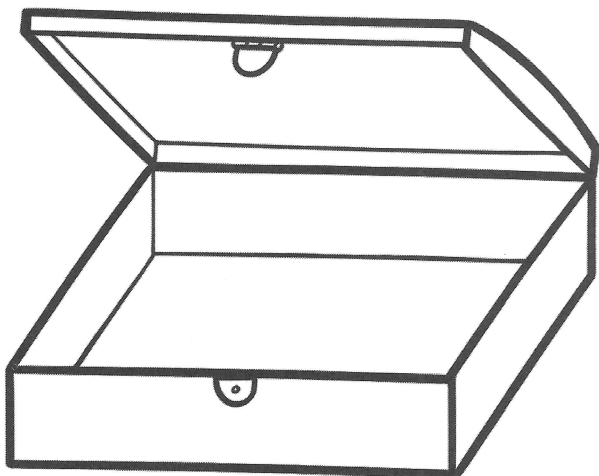

Écris ensuite le nombre de coffres remplis et le nombre
de pièces.

- Avec aide
- Sans aide

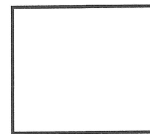
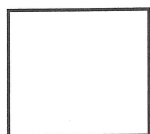
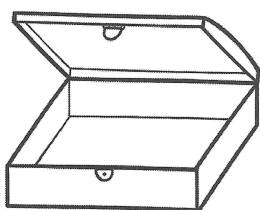

Dire: " 3 coffres de 10 pièces c'est aussi 30 pièces."